

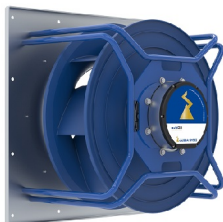

1



GR63C-ZIK.GG.CR | 116792/A01 | Portfolio STD-WW | Cpro ECblue

### Standard design with ECblue motor and integrated electronics

#### Material of impeller:

- ZAmid - high performance composite material

#### Color Coating:

- Color coating in RAL5002 (Ultra marine-blue)

#### Mains voltage motor size B\_:

- 1~ 200...277 V; 50/60 Hz

#### Mains voltage motor size D\_:

- 1~ 200...277 V; 50/60 Hz
- 3~ 200...240 V; 50/60 Hz
- 3~ 380...480 V; 50/60 Hz

#### Mains voltage motor size G\_:

- 3~ 200...240 V; 50/60 Hz
- 3~ 380...480 V; 50/60 Hz

#### Thermal class:

- THCL155

#### Thermal protection:

- Protection with active temperature management

#### Protection:

- IP55

#### Coating:

- Motor painted in RAL5002 (Ultra marine-blue)

#### Controller (only motor size B\_):

- Activation via external speed setting 0-10 V / PWM, Communication interface on request
- Standard cable length: 60 cm

#### Controller (only motor size D\_, G\_):

# FANselect



- **BASIC:**

Activation via external speed setting 0-10 V / PWM Art. no. ER- and GR-module  
in basic version

- **PREMIUM:**

Integrated control functionality, Communication interface on request

**Cable glands:**

- Motor size D: 3 x M16 x 1.5
- Motor size G: 3 x M20 x 1.5

**Ambient temperature:**

- Minimum permissible ambient temperature: -20 °C\*
- Maximum permissible ambient temperature: 40 °C or see data sheet

**\*Continuous operation with occasional starts (S1) according to DIN EN 60034-1: 2011-02. Occasional starting between -35 ° C and -25 ° C is permissible. Permanent operation below -25 ° C only possible with special bearings for refrigeration applications on request.**



## fan data

16/12/2021

version FANselect V 1.01 (211209), AMCA V 1.03 September, 2021 / 1.21.12.09 | 53567 | (user ZAFS43567)



type	GR63C-ZIK.GG.CR
article no.	116792/A01   Portfolio STD-WW

## technical data

motor	ECblue	
Efficiency class	IE5	
mains supply	-	3~ 400V 50Hz
ambient temperature, max. limit ( $t_r$ )	°C	40
efficiency grade $\eta_{statA}$	%	65,5
efficiency grade $N_{actual}$   $N_{target}$		71,1   62
ErP-conformity		2015   EC controller integrated
grille   influence		no

## fan data

SFP-class   SFP-value ( $P_{SFP}$ )	-   Ws/m <sup>3</sup>	4   1308
airflow volume ( $q_v$ )	ft <sup>3</sup> /min	4133.7
air velocity	ft/s	17.02
pressure, stat. ( $p_{sF}$ )   tot. ( $p_F$ )	in.wg.	2.981   3.044
electrical power input ( $P_{sys}$ )	W	2551
system eff., stat. ( $\eta_{sF,sys}$ )   tot. ( $\eta_{F,sys}$ )	%	56.8   58.0
fan speed ( $n$ )   max. ( $n_{max}$ )	rpm	1199   1200
fan speed, set value (% $n_{max}$ )	%	100
frequency ( $f_{BP}$ )   ( $f_{max}$ )	Hz	50   60
voltage ( $U_{DP}$ )	V	400
current ( $I_{DP}$ )	A	3.91
acoustics, suction side ( $L_{w(A),5}$ )   ( $L_{w,5}$ )	dB	75   84
acoustics, pressure side ( $L_{w(A),6}$ )   ( $L_{w,6}$ )	dB	81   88
dimensions (w x h x d)	in	33.07 x 33.07 x 20.12
product weight ( $m_{pr}$ )	lb	156.5
k-factor nozzle pres. (k)	-	381
differential pres. nozzle ( $p_{sF \text{ nozzle}}$ )	Pa	340

PF:PF\_50; Ano:116792; STot:+-10 %





performance curve / acoustics

16/12/2021

version FANselect V 1.01 (211209), AMCA V 1.03 September, 2021 / 1.21.12.09 | 53567 | (user ZAFS43567)

- 1 **GR63C-ZIK.GG.CR** measured in standard nozzle in installation type A according to ISO 5801  
 116792/A01 | Portfolio measurement density 0.072 [lbs/ft<sup>3</sup>]  
 STD-WWW

air performance p<sub>sF</sub>

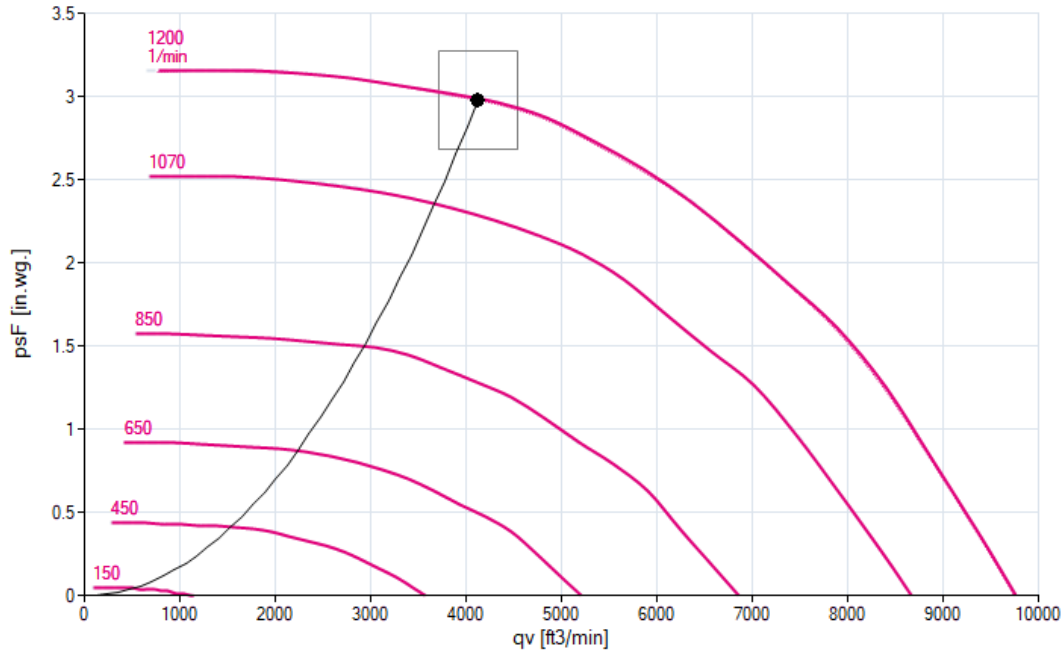

acoustics (L<sub>w(A),5</sub>)

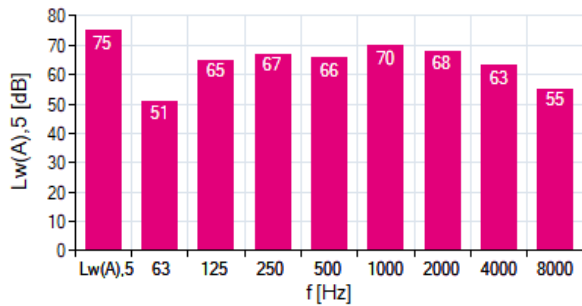

acoustics (L<sub>w(A),6</sub>)

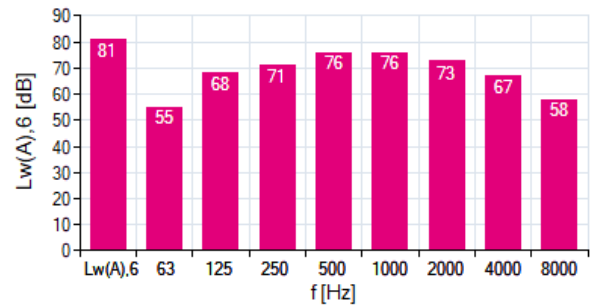

1 GR63C-ZIK.GG.CR

f [Hz]	sum	63	125	250	500	1000	2000	4000	8000
L <sub>w(A),5</sub>	75	51	65	67	66	70	68	63	55
L <sub>w,5</sub>	84	76	82	76	69	70	67	62	57

f [Hz]	sum	63	125	250	500	1000	2000	4000	8000
L <sub>w(A),6</sub>	81	55	68	71	76	76	73	67	58
L <sub>w,6</sub>	88	81	85	80	79	76	71	66	59

# FANselect



efficiency grade / power input 16/12/2021  
version FANselect V 1.01 (211209), AMCA V 1.03 September, 2021 / 1.21.12.09 | 53567 | (user ZAFS43567)

① **GR63C-ZIK.GG.CR** measured in standard nozzle in installation type A according to ISO 5801  
 116792/A01 | Portfolio measurement density 0.072 [lbs/ft<sup>3</sup>]  
 STD-WWW

efficiency grade  $\eta_{F,sys}$

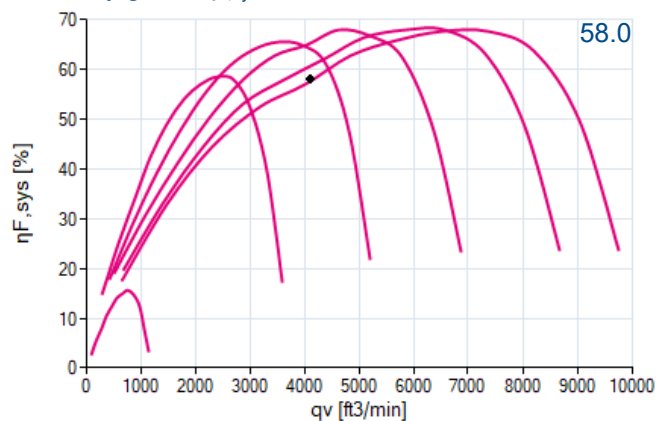

efficiency grade  $\eta_{sF,sys}$

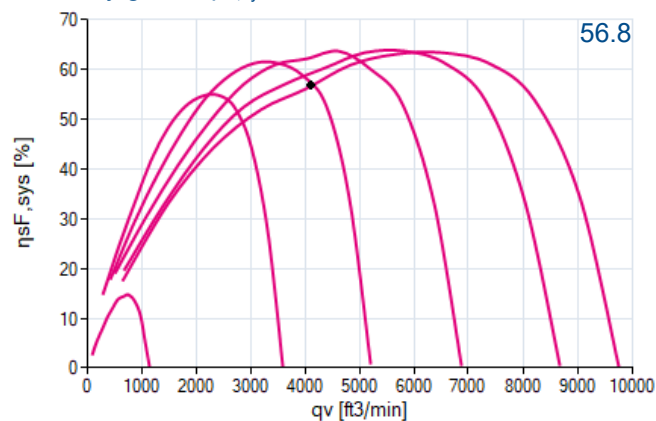

power input  $P_{sys}$

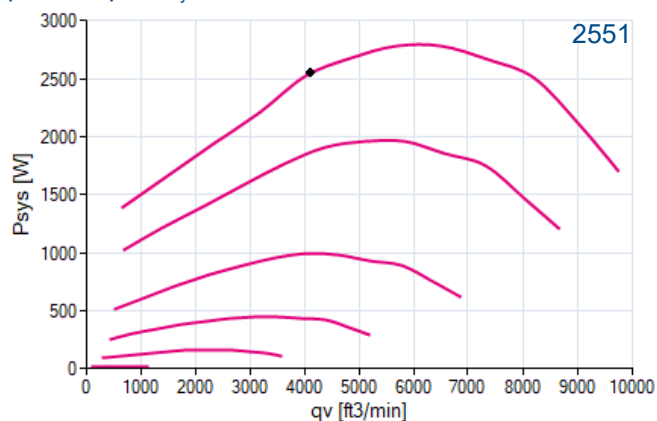



## nominal values

16/12/2021

version FANselect V 1.01 (211209), AMCA V 1.03 September, 2021 / 1.21.12.09 | 53567 | (user ZAFS43567)

1

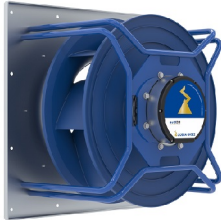

**GR63C-ZIK.GG.CR**  
116792/A01

3~ 380-480V 50Hz P1 2.90kW  
4.80-3.80A 1200/MIN 40°C  
3~ 380-480V 60Hz P1 2.90kW  
4.80-3.80A 1200/MIN 40°C  
IP55 THCL155

## drawing

16/12/2021

version FANselect V 1.01 (211209), AMCA V 1.03 September, 2021 / 1.21.12.09 | 53567 | (user ZAFS43567)

1

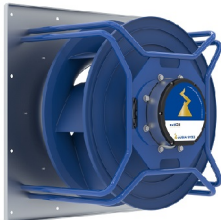

**GR63C-ZIK.GG.CR**  
116792/A01

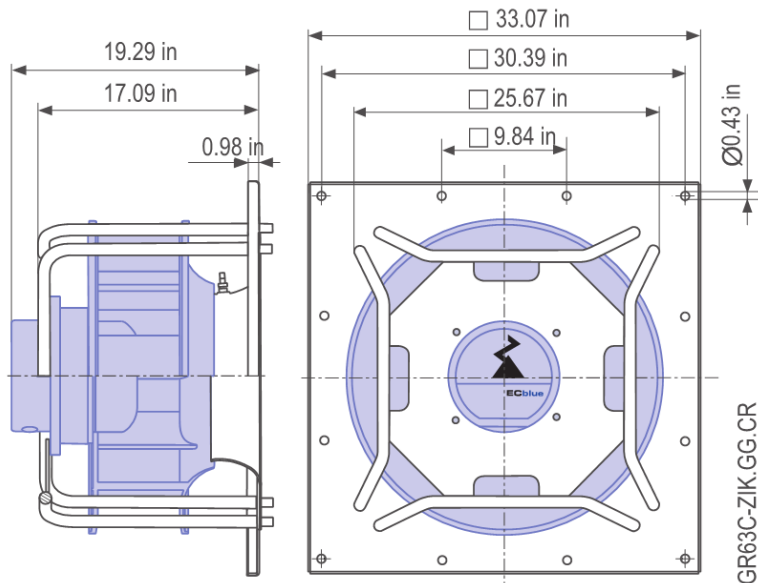

## wiring diagram

16/12/2021

version FANselect V 1.01 (211209), AMCA V 1.03 September, 2021 / 1.21.12.09 | 53567 | (user ZAFS43567)

1

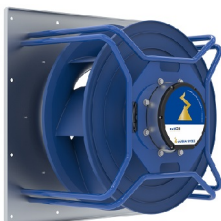

**GR63C-ZIK.GG.CR**  
116792/A01

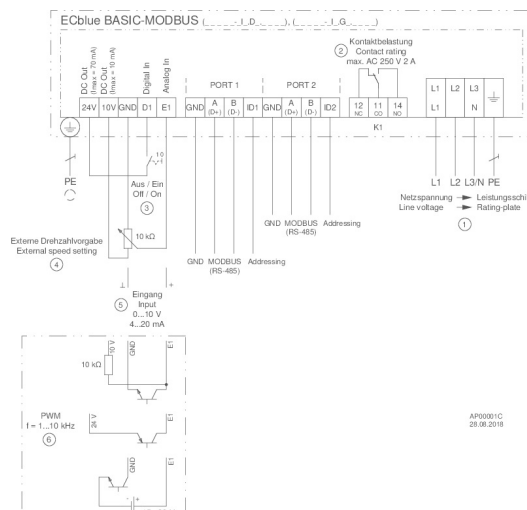



## system components

16/12/2021

version FANselect V 1.01 (211209), AMCA V 1.03 September, 2021 / 1.21.12.09 | 53567 | (user ZAFS43567)

1



type	GR63C-ZIK.GG.CR
article no.	116792/A01

